

# Actuator, Klappenstellantrieb, Электропривод, Servophonon

FS10S..., FS15S...

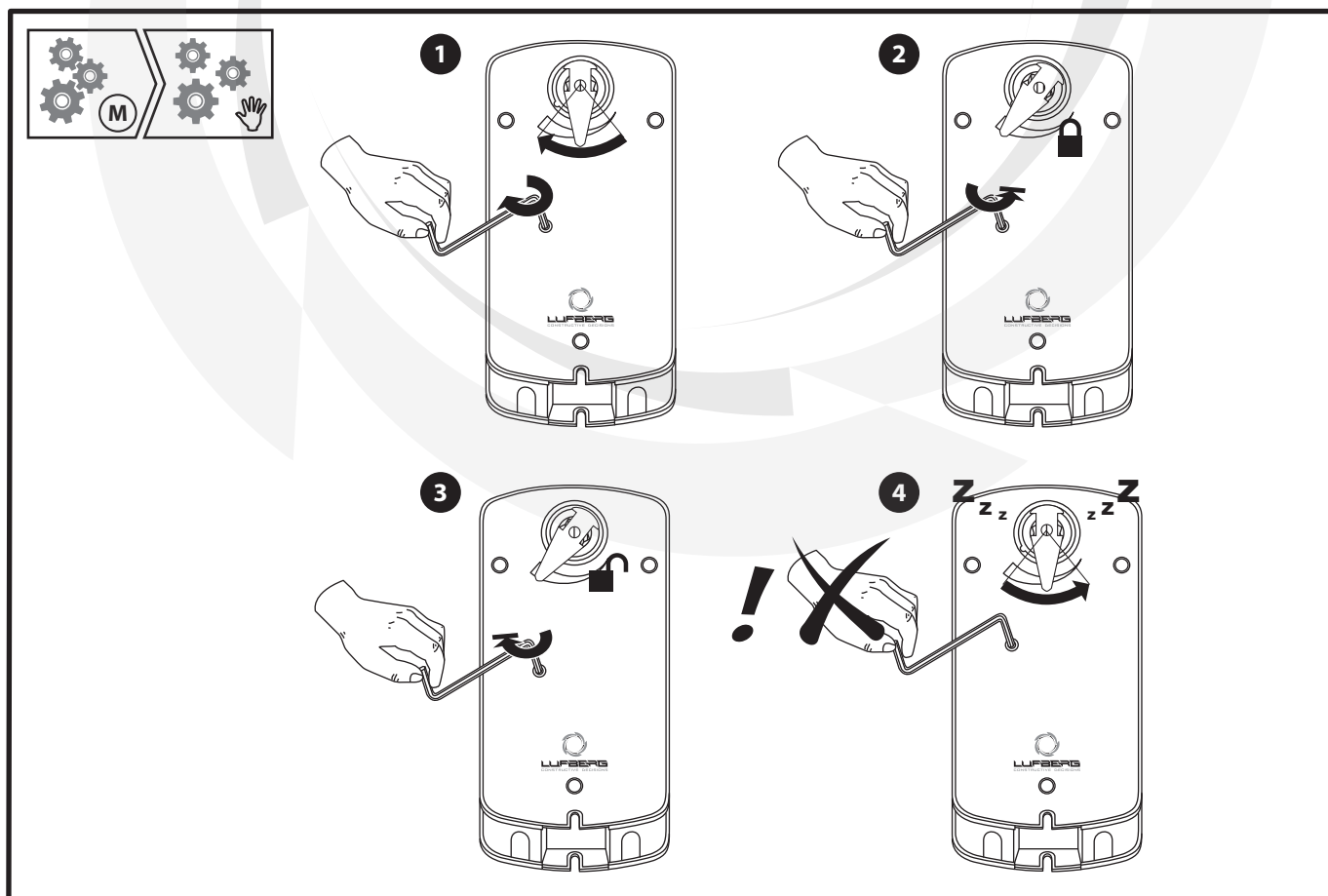

**LUFBERG**  
CONSTRUCTIVE DECISIONS

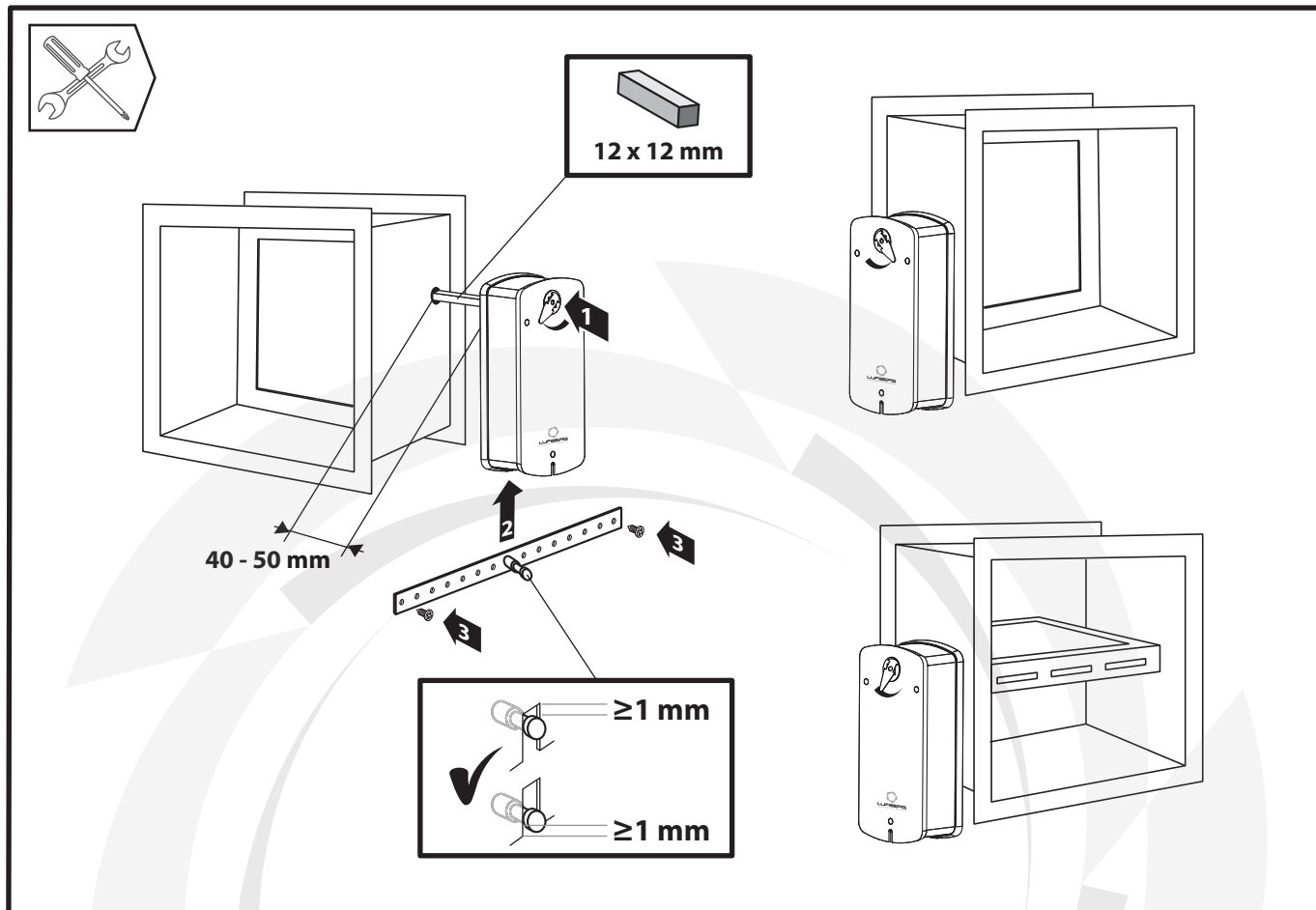

# Actuator, Klappenstellantrieb, Электропривод, Servorohon

FS10S..., FS15S...



**LUFBERG**  
CONSTRUCTIVE DECISIONS

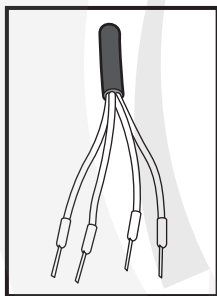
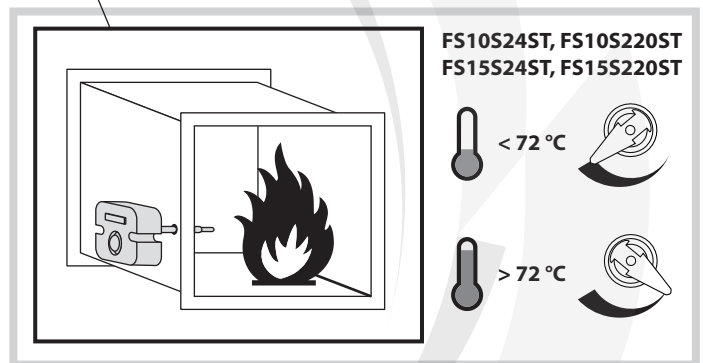
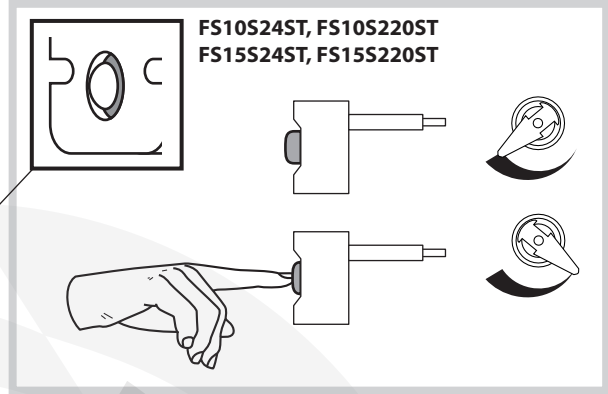
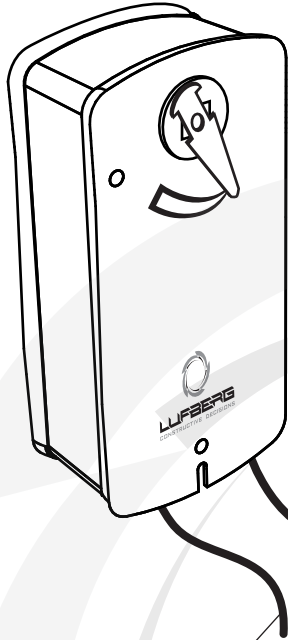
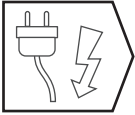

FS10S24S, FS10S24ST, FS10S220S, FS10S220ST  
FS15S24S, FS15S24ST, FS15S220S, FS15S220ST,

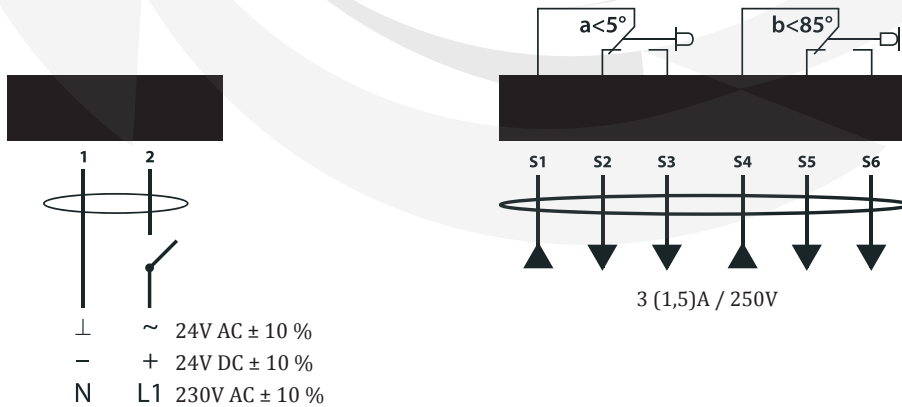

All rights reserved.  
 The company Lufberg reserves the right to change technical specifications of product without previous announcement.  
 On these product was issued Declaration of conformity in accordance with those directives: the Low Voltage Directive 2006/95/EC, the Electromagnetic Compatibility Directive 2004/108/EC and Machinery Directive 2006/42/EC

FS10S..., FS15S...

